











Includes:

STANDARD / XL / XXL
 3/4" (20 mm) hose barbs

XS
 1/2" (13 mm) hose barbs

Main Body *1

Accessories:

- XS:  *2  *2  *1
 - STANDARD / XL:  *2  *2  *1
 - XXL:  *4  *4  *2
-  1/2" (13 mm) hose barbs *2
 1/2" (13 mm) hose barbs *4

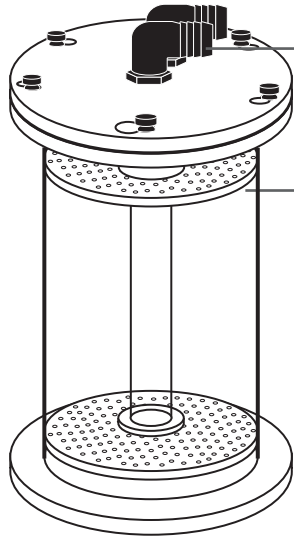

Recommendations

- 1.** While we take great care to keep any contaminants away from our products during assembly, please take a moment to clean the reactor and plumbing before attaching to your tank. Only clean your reactor with warm water. Never clean Acrylic with alcohol based products. Use caution when handling as acrylic scratches easily.
- 2.** Please keep in mind that a media reactor is intended to be a bypass filter, and is not designed to handle the complete flow and pressure requirements of a large aquarium system.
- 3.** Some media (such as phosphate control products) is not designed to be aggressively fluidized in a reactor – please read the instructions on your media carefully.
- 4.** The reactor should be cleaned out every time that the media is replaced ensuring that there is no media below the bottom plate.

Filling Your Media

- 1** Loosen the thumb screws. Turn lid counterclockwise to release.

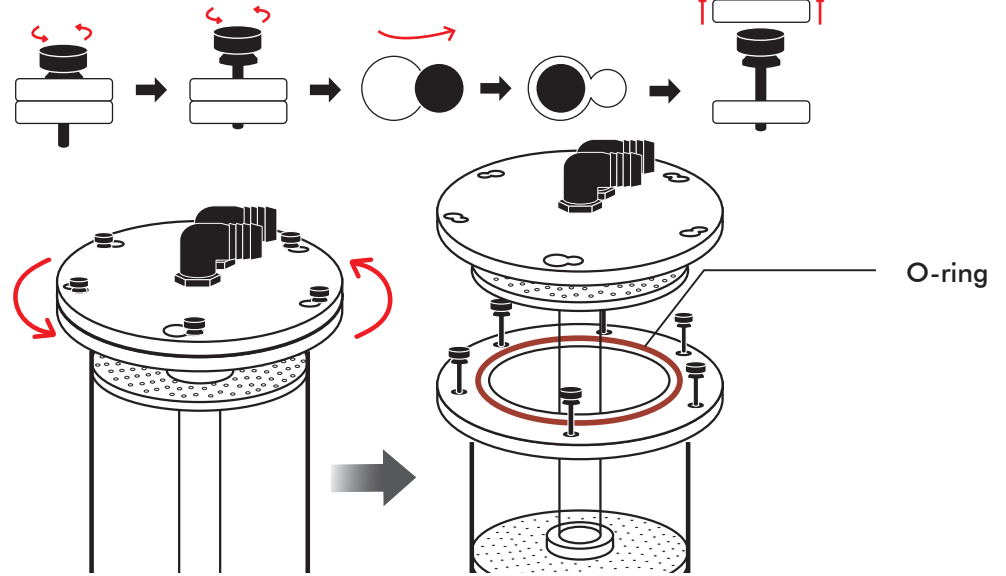

- 2** (Only if you need to switch the hosebarbs from 3/4" to 1/2")
 The included hosebarbs could be switched from 3/4" to 1/2", just unscrewing the hosebarbs' fasteners from beneath the lid, then pressing the hosebarb upward out of their hexagonal recess.

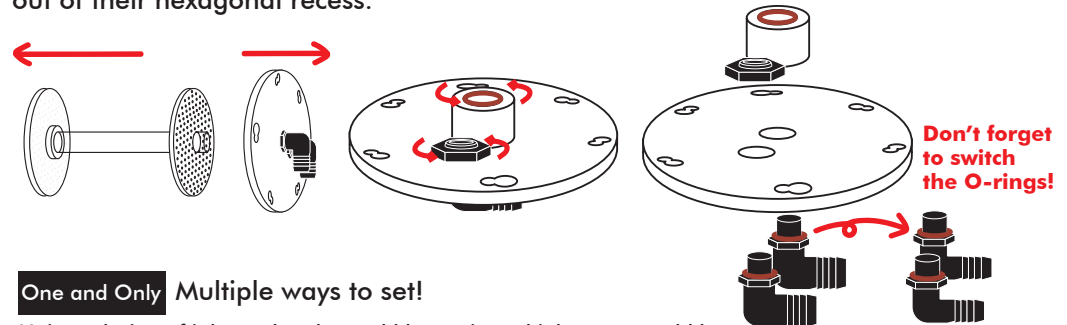

One and Only Multiple ways to set!

Unique design of inlet and outlet could be set in multiple ways, could be suitable for any tubing.

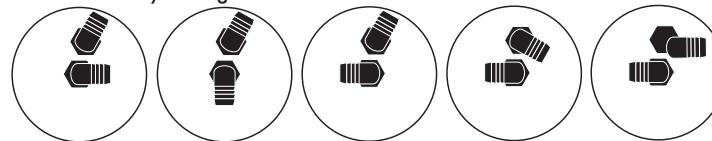

- 3 If the diameter of your media is above 2mm, you can skip to 5. Because the set of filter sponges is not necessary for bigger media, please read the instructions of your media carefully.

Remove the upper media plate and the O-ring.

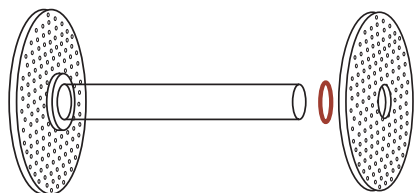

- 4 Install the set of filter sponges. Make sure the sponge is all the way at the bottom of the reactor, flush against the plate – otherwise the media may leak past it when filling.

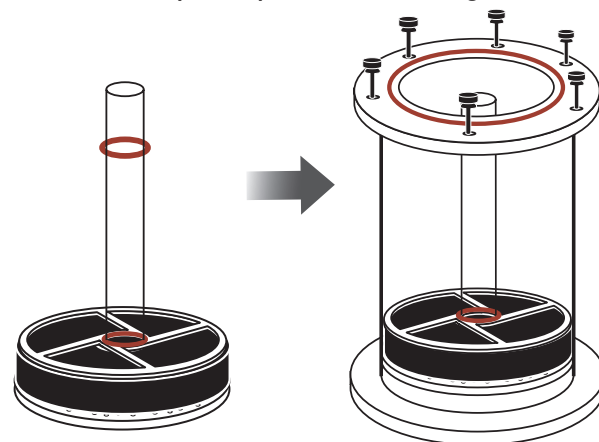

- 5 Now you can fill in your media, but watch out not to fill into the central tube. You can temporarily block the top of the central tube to stop media from going down the central tube.

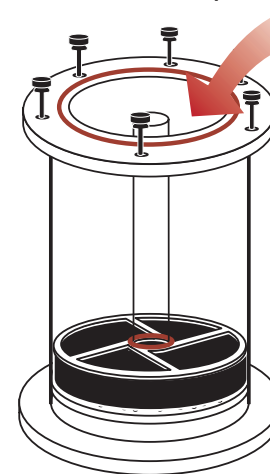

the reactor should be filled no more than 2/3 full to allow the media room to move around. With heavy or fine media, you may need to add less.

- 6 Install the rest of the set of filter sponges (not necessary if media diameter is above 2mm) and the upper media plate. The plenum may fit snugly, please use caution when sliding it on.

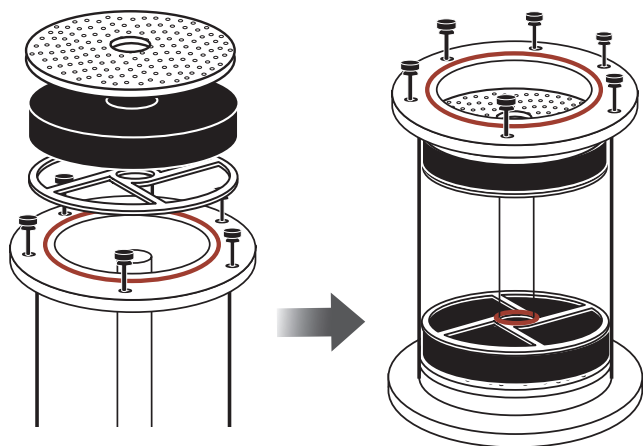

- 7 Replace the reactor lid, turn clockwise and gently tighten the thumb screws. CAUTION: DO NOT OVER TIGHTEN THE SCREWS.

Tips: Tighten the screws in a star pattern to evenly secure the lid.

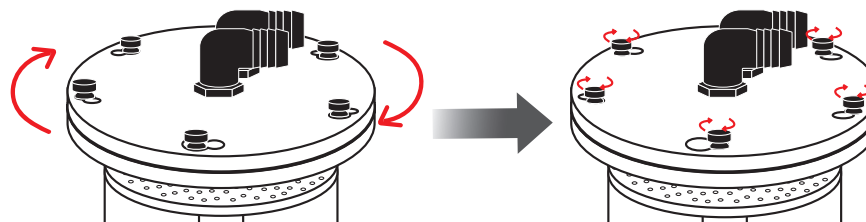

- 8 Connect the Inlet and outlet hose to Inlet and outlet fitting of the lid.

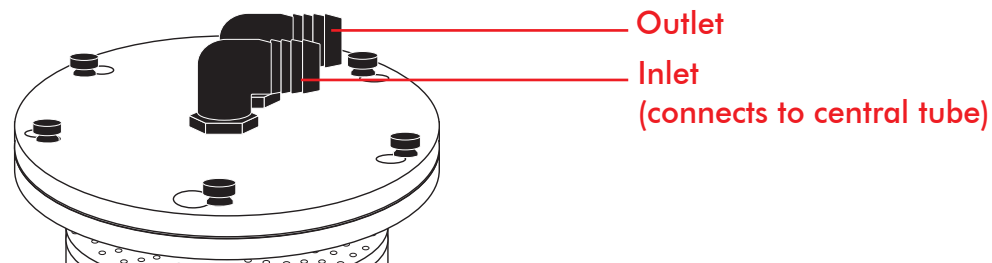

Warranty

AquaMaxx warrants all AquaMaxx products to be free from manufacturing defects for one year from the original purchase date when purchased through an authorized AquaMaxx retailer. This warranty does not cover any damages caused by misuse, neglect, alterations or improper handling / transport / maintenance / installation. Physical damages are not covered by warranty. AquaMaxx does not cover personal injury, personal loss, or other damages associated with the use of our products. In order to request warranty service, please email us at info@aquamaxxaquariums.com. A purchase receipt is required for any warranty service. Products requiring warranty service must be returned to AquaMaxx. You are responsible for the cost of shipping a warranty claim to AquaMaxx and any damages that may occur during transit. Once a returned product has been inspected, it will be repaired or exchanged at our discretion and returned to you. International and/or expedited shipping are not covered under your AquaMaxx warranty.